

AMANO®

CP-5000

Electronic Time Recorder

User's Guide



Proprietary Notice

This document contains proprietary information and such information may not be reproduced in whole or part without the written permission from Amano Cincinnati, Inc. 140 Harrison Ave., Roseland, New Jersey 07068.

Amano Cincinnati, Inc. reserves the right to make equipment changes and improvements which may not be reflected in this document. Portions of this document may have been updated to include the latest hardware or firmware version, if applicable.

To ensure safe use of this time recorder/stamp, be sure to thoroughly read this manual in its entirety before any attempt is made to operate the equipment. After you have finished reading this manual, be sure to store it and in a safe place for further reference.

Thank You...

For purchasing another fine product from

Amano Cincinnati, Inc.

Table of Contents

Chapter 1: Introduction	1-1
Specifications	1-1
Accessories	1-2
Names and Functions of Parts	1-3
Front Panel Description.....	1-3
Chapter 2: Getting Started	2-1
Top Cover	2-1
Front Cover	2-2
Removal	2-2
Installation	2-2
Placement/Location.....	2-3
Desktop Installation	2-3
Wall Mounting.....	2-4
External Signal Connections	2-6
Optional Accessory Battery Pack (ATR-20095x).....	2-8
Installation	2-8
Power Connection	2-9
Initialization and Reset	2-10
Reset Button.....	2-10
Initialization (All Clear).....	2-10
Chapter 3: Time Cards	3-1
Making a Test Print	3-1
Chapter 4: Programming	4-1
Introduction	4-1
General Programming Guidelines	4-1
Entering Program Mode	4-1
Entering and Saving Values	4-2
Scrolling Through the Program Mode.....	4-2
Exiting Program Mode.....	4-2
Programming Guide	4-3
Basic Programming	4-6
Programming Password (Menu 3).....	4-6
Year, Month, and Date (Menu 1, Items 1 & 2)	4-6
Hours and Minutes (Menu 1, Item 3)	4-8
Daylight Savings Time (DST) (Menu 2).....	4-9
Automatic Adjustment Settings.....	4-9
Programming DST (Menu 2, Items 1 – 3).....	4-10
Disabling DST	4-11
Hours Display and Imprint (Menu 4, Items 1 – 7)	4-12
Index Number Imprint (Menu 4, Item 8).....	4-14
Signal Duration (Menu 5, Item 1)	4-14
Weekly Programming (Items 01 – 80).....	4-15
Functions Available in Weekly Programming	4-15
Creating a Weekly Program	4-16

Obtaining a Printout of Programmed Data (Menu 7).....	4-18
Editing Weekly Programs	4-19
Adding Additional Weekly Programs.....	4-19
Deleting a Weekly Program	4-20
Chapter 5: Maintenance.....	5-1
Service.....	5-1
Exterior	5-1
Ribbon Replacement	5-1
Time/Date Memory Backup Battery	5-3
Chapter 6: Troubleshooting	6-1
Introduction	6-1
General Problems.....	6-1
Signal.....	6-1
Foreign Object or Material	6-2
Programming	6-2
Key Failure.....	6-2
Audible Beeps.....	6-2
Error Messages	6-3
Err 1 thru Err 9	6-3
Display Related Problems	6-7
Low Battery.....	6-7
Power Failure.....	6-7
Inaccurate Clock	6-7
LED's Not Functioning	6-7
Hour Change	6-8
Card Feed Problems.....	6-8
Card Refused.....	6-8
Card Cannot Enter or Card Blocked	6-8
Card Refused, Date and Time in Display	6-9
Imprint Problems.....	6-9
Overprint	6-9
Imprint Position Wrong.....	6-9
Wrong Color Printed	6-10
Weak or Light Printing	6-10
Diagnostics (Menu 8).....	6-11
LED Test (Menu 8, Item 1).....	6-11
Mode and Keys Test (Menu 8, Item 2).....	6-12
LCD Test (Menu 8, Item 3)	6-13
EPROM (Memory) Test (Menu 8, Item 4)	6-13
Buzzer Test (Menu 8, Item 5)	6-14
Signal Test (Menu 8, Item 6).....	6-15
Motor Test (Menu 8, Item 7)	6-15
Firmware Version Number (Menu 8, Item 8).....	6-16
Print Counter (Menu 8, Item 9)	6-16
Card Print Test (Menu 8, Item 10)	6-16
Chapter 7: Appendix.....	7-1

Chapter 1: Introduction

Before attempting to use the Amano CP-5000 time recorder/stamp, please carefully review Chapter 1: "Introduction", Chapter 2: "Getting Started", Chapter 3: "Time Cards", and Chapter 4: "Programming". This chapter of the manual covers the specifications, accessories, names and functions of parts, LCD Display, and description of controls.



Specifications

Power Requirements:	120 VAC \pm 10%, 50/60 Hz
Power Consumption:	6 W Idle, 60W maximum
Ambient Temperature:	32°F to 113°F (0°C to 45°C)
Ambient Humidity:	10% to 90% (non-condensing)
Dimensions:	12.3" (313 mm) High X 10.2" (259 mm) Wide X 6.1" (155 mm) Deep.
Weight:	Approximately 9.00 lbs. (4.1 kg)
Environment:	Indoor use only; dust-free environment. Keep out of direct sunlight.
Mounting:	Wall or Table Mount
Time Card:	Amano Time Cards Amano Part Number: C-3000 Time Cards 3.36 \pm .016" (85.4 \pm .4mm) (W) x 8.27" (210mm) (H) 150 lb. Manila card (.0126" (0.32mm) thick)
Ribbon:	Two-color cartridge Amano Part Number: CE-316452

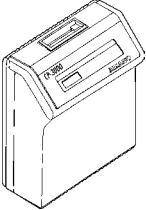

Accessories

The following accessories are provided with the Amano CP-5000. After unpacking, please ensure that all of the following items are provided:

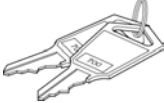
 <p>CP-5000 (1 unit)</p>	 <p>User's Guide</p> <p>This User's Guide (1 copy)</p>	 <p>Keys (one pair, 2 keys)</p>
---	---	--

- Please note that specifications, appearance, and/or description are subject to change without notice due to product enhancements.
- This user's guide has been carefully prepared, but Amano assumes no liability for errors and/or omissions. If you should find any errors or unclear information, please contact your Amano dealer.

Names and Functions of Parts

The following describes the names and functions of various parts of the CP-5000.



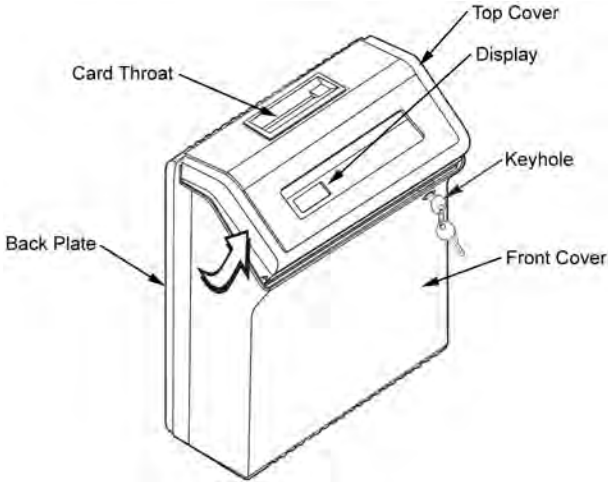

External View

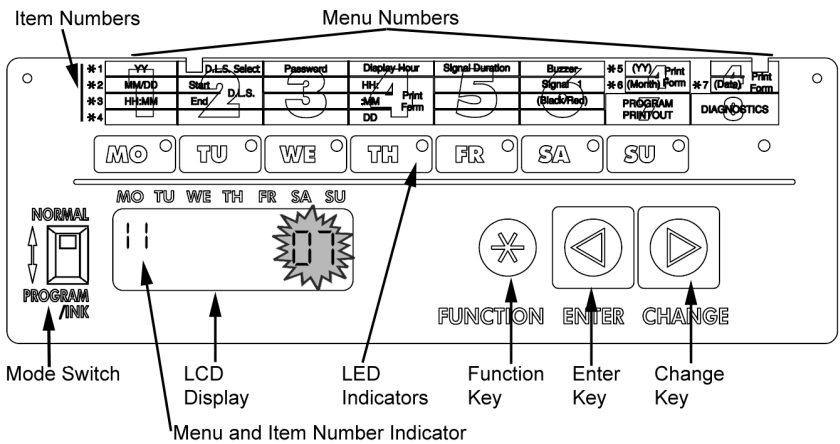

Front Panel Description

The front panel displays the date, time, day of the week, and is used for programming the unit. It is accessed by removing the top cover. (see Chapter 2: "Getting Started" for more details).



Component	Name	Normal Mode	Program/Ink Mode
	LED Indicator	Day of the week	Current menu in display
	Mode Switch	Normal Operation	Enter Program/Ink Ribbon replacement mode
	Function Key	Not Available	Move to the next menu
	Enter Key	Not Available	Accept data in the display, and move to the next item in the current menu or next menu.
	Change Key	Not Available	Edit data in the display. Pressing this key will increment the displayed value by one. Holding the key down for more than three seconds will increment the displayed value by ten.

Note: ESD (Electrostatic Discharge) precautions should be observed before removing the top cover.

Chapter 2: Getting Started

Before using the Amano CP-5000 time recorder/stamp, please carefully review this chapter of the manual, which covers:

- Top cover removal and installation
- Front cover removal and installation
- Placement/Location
- Desktop Installation
- Wall Mounting
- External Signal Connections
- Battery Connection
- Initialization and Reset
- Power Connection

Top Cover

The top cover must be removed to configure, install, and program the CP-5000. To remove the top cover, follow these steps:

1. Insert the key provided in the keyhole, and turn the key clockwise to unlock the cover. The top cover should “pop” open.
2. Pivot the top cover upwards, and lift the cover to remove.
3. To re-install the top cover, set and align it with the grooves on the housing, then press it into place until it clicks.

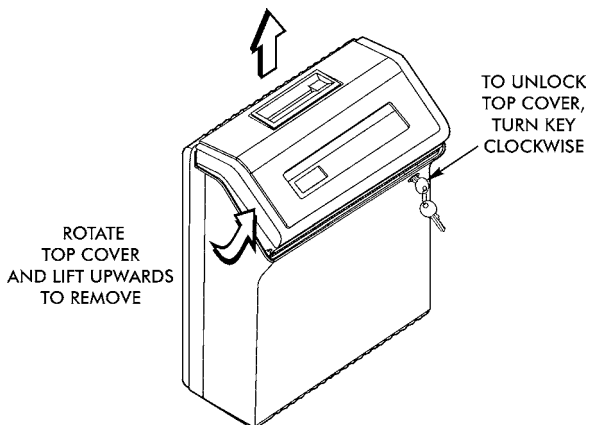

Front Cover

Removal

The front cover must be removed to connect the Full Power Reserve Battery and connect the external signal line for the CP-5000. To do so, perform the following steps:

1. Disconnect the power cord from the power source if applicable.
2. Remove the top cover.
3. Lay the unit face up on a flat surface.
4. Facing the front of the unit, remove the two Phillips head screws in the upper corners of the housing.

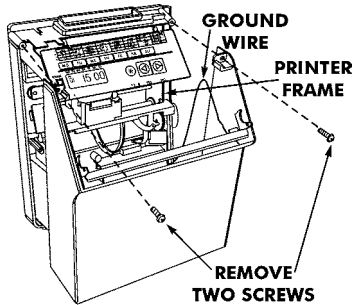

5. Press both of your hands flat against the sides of the front cover.
6. Pivot the front cover towards you. Support the front cover so that it doesn't stress the ground wire connections. Set face up on a flat surface.

Installation

1. With the front cover on a flat surface and facing up, press both of your hands flat against the sides.
2. Facing the bottom of the unit, set and align the tabs on the bottom of the front cover with the grooves on the housing.
3. Pivot the front cover towards the housing. Reconnect the ground wire, push the cover down in place and secure it with the two Phillips head screws.
4. Reinstall the top cover. Reconnect the power cord to the power source.

Placement/Location

When choosing a mounting location for your CP-5000, you should ensure the following parameters are met:

- The mounting surface and hardware is capable of supporting the unit's weight, approximately 10 lbs., or 4.54 kg.
- The area must be within the specified operating temperature range (see page 1-1).
- The unit has access to a power source (AC wall outlet).
- The area can accommodate signal and/or power conduits.
- The following conditions do not exist:

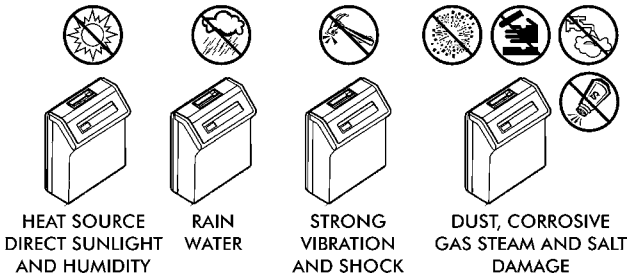

Desktop Installation

Place the time recorder on a level surface. The recommended height of the surface should be 29½" (75 cm) from the floor.

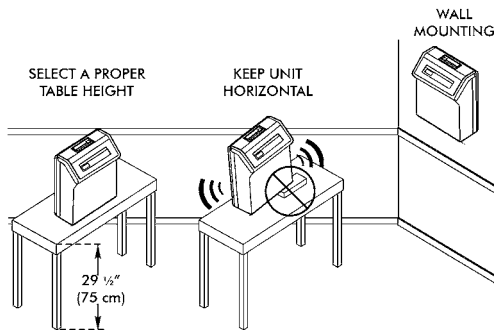

Wall Mounting

For proper wall mounting, follow these steps:

1. Disconnect the power cord from the power source.
 2. Unlock and remove the top cover.
 3. Remove the two screws on the top and slide the back plate downward to remove it. Set the CP-5000 face up on a flat surface.
- Note:** The right side back plate screw also secures a ground wire.
4. Using a punch, knock out the center material from the teardrop-shaped mounting hole on the back plate.
 5. Using the back plate as a template, approximate the final location of the clock, and mark the location of the teardrop mounting hole on the wall.
 6. Hang the back plate on a screw or anchor from the teardrop-shaped mounting hole.
 7. Level the back plate and mark the location of the bottom two mounting holes.
 8. Secure the back plate to the wall by inserting screws through the bottom two mounting holes.

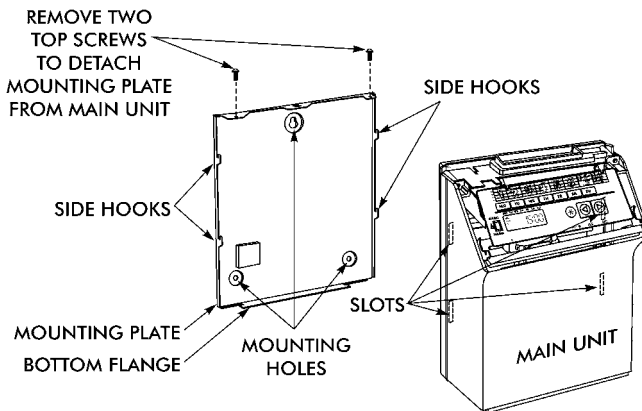

9. Holding the sides of the cover, lift the CP-5000, bottom forward, to the back plate.
10. Align the tabs on the bottom of the CP-5000 housing with the grooves in the bottom flange of the back plate. Hold the CP-5000 in place so that the tabs are even with the bottom flange. Do not rest the unit on the flange.

11. Carefully pivot the CP-5000 away from you onto the back plate until its side hooks fit in the slots on the back of the unit. The upper flange of the back plate should be aligned with the slot in the top of housing.

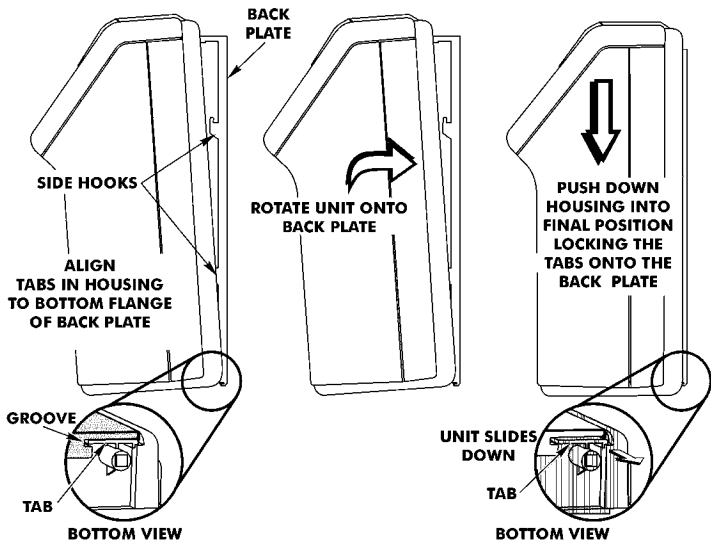

12. Install the two screws that secure the back plate to the unit. Make sure you re-install the ground wire.
13. If you need to connect external signal wiring, or connect the battery, do not replace the top cover or reconnect the power cord at this time.

External Signal Connections

The CP-5000 is equipped with a single external signal relay circuit that enables you to activate an audible device such as a bell or buzzer. The relay contacts of the circuit are Normally Open and should not exceed Class 2 Circuit requirements (24 VDC at 1A). The duration (in seconds) that the relay contacts will be activated or closed is set in the **Signal Duration** menu item, and the time of the day and day of the week that this will occur on is set in the **Weekly Programming** menu.

The wiring schematic for the external signal relay circuit is as follows:

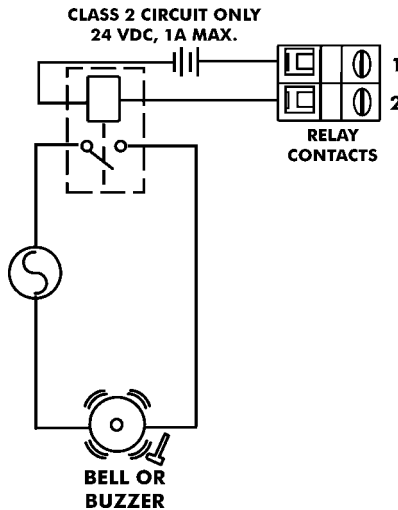

Note: This procedure must be performed with power to both the external device and the CP-5000 disconnected.

To connect a device to the relay signal circuit, perform the following steps:

1. Make sure that power to both the external device and the CP-5000 are disconnected.
2. Following the manufacturer's guidelines for the external device, connect the signal wires to it and run them to the mounting location of the CP-5000. Make sure the wires are properly labeled.

- Strip approximately .25" (6 mm) of insulation off the ends of the wires that will be connected to the CP-5000.
- Remove the top cover from the CP-5000.
- Remove the front cover; support the cover so that it doesn't hang from the ground wire.
- With the unit flat and face up, locate terminal block **TB1**.
- Using a small-blade screwdriver, loosen the screws on the **TB1** side of the connector block.
- Observing polarity, insert one wire into the CP-5000 through the open hole and connect it to the proper terminal position of **TB1**. Using a screwdriver, secure the wire in place. Insert the other wire into the unit and secure in place. Make sure that only the stripped wire is clamped, and not the insulation.

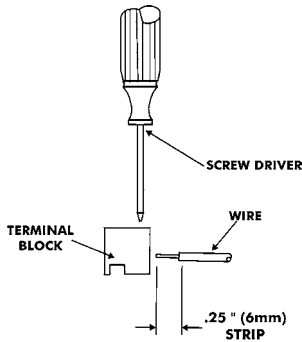

- Check the connections by tugging on each wire. If they appear loose, repeat the previous step.
- Clamp the signal wires as shown in the following drawing using a cable clamp appropriate to your cable thickness.

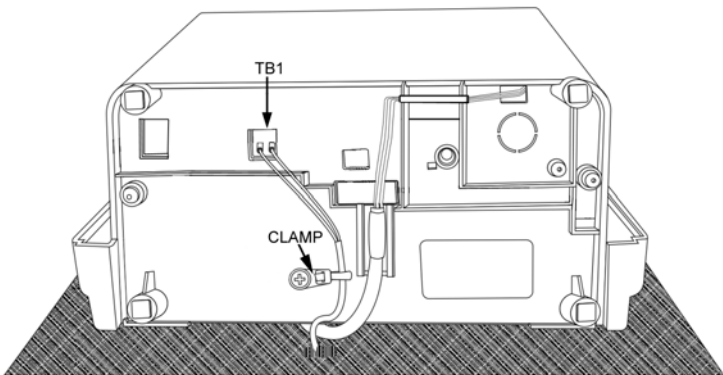

Optional Accessory Battery Pack (ATR-20095x)

Installing the Full Power Reserve Battery (available as a kit: P/N ATR-20095x) will allow the CP-5000 to maintain normal operations for 12 hours or 300 punches in the event of an AC power failure.

Installation

Note: This procedure must be performed with the power cord disconnected from the power source.

To install the Full Power Reserve Battery perform the following steps:

1. Remove the top cover.
2. Remove the front cover.
3. Remove the back plate.
4. Remove the backing paper from the Velcro.

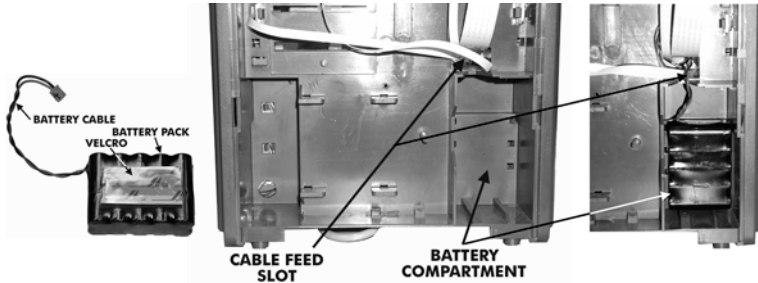

5. Slide the battery pack into the compartment and press firmly into place to allow the adhesive on the Velcro fastener to hold.
6. Feed the battery cable through the cable feed slot at the top of the battery compartment and over the top of the PC board.
7. Connect the battery cable to **FPR** on the PC Board.

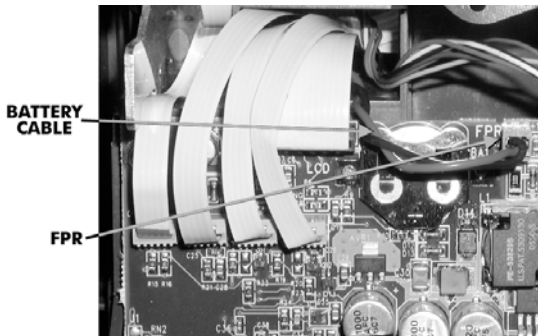

Note: The battery will not power the clock until after the clock is initially plugged in. Afterwards, power will automatically be supplied by the battery in the event of an AC power failure.

8. Replace the back plate
9. Replace the front cover.
10. Replace the top cover.

Note: To insure premium performance it is recommended that the battery be fully charged prior to use (approximately 24 hours).

Note: To avoid damaging the battery, or draining it to an unrecoverable level, keep the machine plugged into an AC power source during normal operation. The power reserve battery is intended to be used for limited power outages, not as a power source during normal operations.

Power Connection

AC Power connections are made by plugging the power cord into a suitable, grounded outlet.

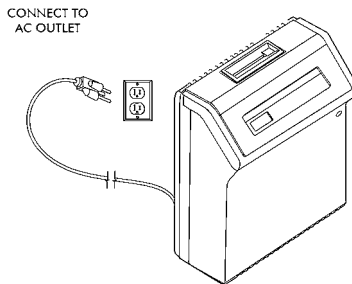

Initialization and Reset

Prior to first use, the CP-5000 must be initialized to clear any possible unexpected program parameters. Initialization (All Clear) erases all user programming and resets the time and date to their default settings.

Reset Button

The **Reset** button can be pressed if the clock becomes unresponsive. This has the same effect as cycling the power, and will not change the time and date or erase any programming.

Insert a small screwdriver into the **Reset Hole** on the bottom of the unit and press the **Reset** button.

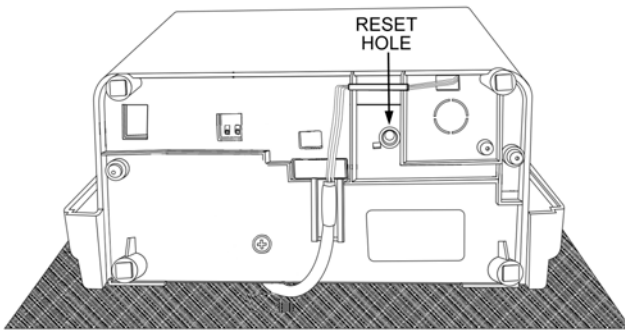

Initialization (All Clear)

This function is provided to clear all programmed settings (weekly programs, imprint formatting, etc.) from the CP-5000. When used, all programming (including time, date and password) will be erased and the unit will be returned to its default settings. You should only initialize your CP-5000 prior to programming a new unit or when instructed to in the Troubleshooting section of this manual.

Note: ESD (Electrostatic Discharge) precautions should be adhered to when removing the top cover.

Initialize your CP-5000 as follows:

1. Remove the top cover. Set the **Mode Switch** to Program/Ink Mode.
2. Insert a small screwdriver into the Reset Hole on the bottom of the unit and press and hold the Reset button.
3. While holding the **Reset** button, simultaneously press and hold the **Enter** key and the **Change** key.
4. Release the **Reset** button; continue to hold the **Enter** key and the **Change** key until five rapid beeps sound, indicating a successful reset to all default settings (showing a time of 12:00 AM on January 1, 2007). After a few moments, the clock will return to its Enter Password mode.
5. Enter the default password (0000) and reprogram the unit as desired. Set the **Mode Switch** to Normal and reinstall the top cover.

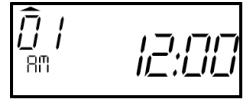

When the AC power is properly connected, the LED will cease to flash and the LCD display will show normal time indication in the (12 hour) format:



Note: If using the Full Power Reserve Battery, to insure premium performance, it is recommended that the battery be fully charged prior to use (approximately 24 hours).

Note: If using the Full Power Reserve Battery, to avoid damaging the battery or draining it to an unrecoverable level, keep the machine plugged into an AC power source during normal operation. The Full Power Reserve Battery is intended for limited power outage usage, and not as a power source during normal operations.

This page intentionally left blank.

Making a Test Print

Follow these steps to make a test print:

1. Make sure that there is power to the CP-5000, and that the top cover is in place.
2. Gently insert a time card into the card throat. The card will automatically be fed in, printed and ejected. Do not force it in or attempt to pull it out before it has been ejected.



3. As shipped, the CP-5000 is configured to print in the following format:

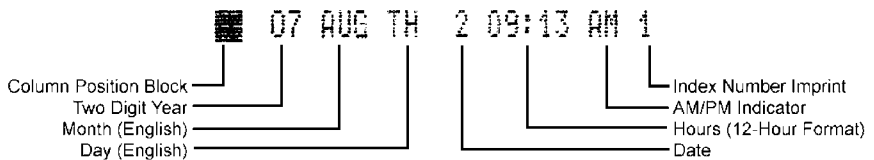

4. If this imprint is acceptable, the CP-5000 is ready to be programmed for use (time and date). If you wish to change the style of the imprint, you must program an imprint style for your application in addition to setting the time and date for your CP-5000. Please refer to the Basic Programming section of Chapter 4 to set year, time, and date imprints.

This page intentionally left blank.

Chapter 4: Programming

Introduction

The CP-5000 must be programmed before use. There are two types of programming: Basic and Weekly.

Basic Programming is used to program clock functions such as time, date, time display, Daylight Saving Time (DST) adjustment, and card imprint.

Weekly Programming consists of activating specific features of the CP-5000 such as the activation of the built-in buzzer, triggering the relay signal contacts, and changing the ribbon color at predetermined times of the day and on specific days of the week.

General Programming Guidelines

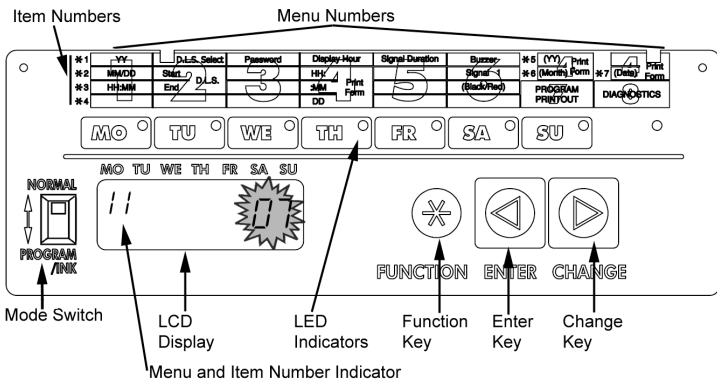

Entering Program Mode

Note: ESD precautions should be observed when removing the top cover.

To enter the Program Mode, remove the top cover and place the **Mode Switch** in the Program/Ink position. After entering the password (page 4-6), the first program menu/item (see Item 5, page 4-13) will appear in the display and the first LED indicator will illuminate.

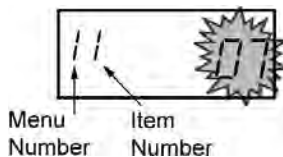

Entering and Saving Values

Values are changed in each programming menu item by pressing the **Change** key. Holding down the **Change** key for more than three seconds will increment the value more rapidly in certain menu items. For example, year values (07 to 50) will be incremented by a value of ten when the **Change** key is pressed for more than three seconds.

To save values entered, press the **Enter** key. Some menus require that several items be sequenced through before the parameters entered can be saved.

All the parameters in the display will flash when an item is ready to be saved. Pressing **Enter** will save the displayed parameters.



Exiting Program Mode or pressing the **Function** key will skip past the item without saving.

Scrolling Through the Program Mode







While in the Program Mode, press the **Function** key to advance to the next menu position. An LED indicator will light for each menu position. Continue pressing the **Function** key and the cursor will eventually return to the first menu.

Exiting Program Mode

To exit the Program Mode at any time, place the **Mode Switch** in the Normal position.

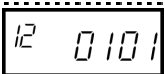
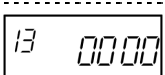
Programming Guide

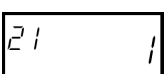
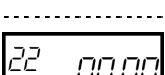
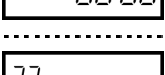

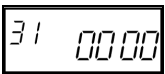





The following is a reference guide for programming the CP-5000:

Indicator	Menu/Item	Description	Display	Accepted Values
MO 	11	Year (page 4-6)		07 to 50
	12	Month and Date (page 4-6)		Month: 01XX to 12XX Date: XX01 to XX31
	13	Hour and Minutes (page 4-8)		Hours: 00XX to 23XX Minutes: XX00 to XX59
TU 	21	Daylight Saving (DST) Mode (page 4-10)		0: Disable 1: Date entry with rolling calendar 2: Based on a specific date
	22	DST Begin (page 4-10)		Month: 01XX to 12XX Date: XX01 to XX31
	23	DST End (page 4-10)		Month: 01XX to 12XX Date: XX01 to XX31
WE 	31	Programming Password (page 4-6)		0000: Disable 0001 to 9999: Password

(Continued on next page)

Indicator	Menu/Item	Description	Display	Accepted Values
<div style="border: 1px solid black; padding: 2px; display: inline-block; font-weight: bold;">TH</div>	41	Hour Display (page 4-12)		1: 24-hour format 2: 12-hour format (default)
	42	Hour Imprint (page 4-12)		1: 24-hour format 2: 12-hour format (default)
	43	Fraction of Hours Imprint (page 4-12)		1: 60 th hour (default) 2: 10 th hour 3: 100 A (36 sec. = 0.01h) 4: 100 B (3 min. = 0.05h)
	44	Day Imprint (page 4-12)		0: Off 1: Day of Week (1 to 7) 2: Day of Week (D1 to D7) 3: Day of Week (English) (default) 4: Day of Week (Spanish) 5: Day of Week (French) 6: Day of Week (German) 7: Day of Week (Dutch) 8: Day of Week (Italian)
	45	Year Imprint (page 4-13)		0: Off 1: On (default)
	46	Month Imprint (page 4-13)		0: Off 1: Month (1 to 12) 2: Month (I to XII) 3: Month (English) (default) 4: Month (Spanish) 5: Month (French) 6: Month (German) 7: Month (Dutch) 8: Month (Italian)
	47	Date Imprint (page 4-13)		0: Off 1: On (default)
	48	Index Number Imprint (page 4-14)		0: Off 1-99: Machine Index Number

(Continued on next page)

Indicator	Menu/Item	Description	Display	Accepted Values
	51	Signal Duration (page 4-14)		1 -15: Signal Duration (seconds)
	01 to 80	Weekly Program (page 4-15)		01 to 80 Programs
	7	Program Printout (page 4-18)		0: Off 1: Program Printout
	8	Diagnostics (page 6-11)		01: LED Test 02: Mode and Keys Test 03: LCD Test 04: Memory Test 05: Buzzer Test 06: Signal Test 07: Motor Test 08: Firmware Version No. 09: Print Counter 10: Card Print Test* 11: Crystal Adjustment* 12: Block Sensor Adjust* 13: Home Sensor Test* 14: Card Sensor Test* 15: Block Sensor Test* 16: Timing Sensor Test* 17: Block Read Test* 18: Sensor Rank Test*

*These tests are for factory use only.

Basic Programming

Programming Password (Menu 3)

Note: As supplied, the CP-5000 is configured with the default password "0000". Whenever a user removes the top cover to enter programming mode, the clock will request a password by displaying 0000. If no password has been configured by the operator, then pressing Enter to accept the default and enter programming mode. If security regarding clock settings is important, it is recommended to configure a password other than the default "0000" setting.

If a password has been programmed, it must be correctly entered in order to modify any of the clock's settings. Proceed as follows:

1. Remove the top cover. The display will show four zeros, the first two of which will be flashing.
2. All passwords contain 4 digits. Using the Change key, enter the *first* two digits of the password.
3. Select Enter. The last two digits will flash. Enter the *last* two digits of the password.
4. Upon correct entry, the currently set month and year will display as seen in the next section.



Note: If no password has been programmed, simply press **Enter** at the four zero prompt.

Year, Month, and Date (Menu 1, Items 1 & 2)

Note: To set the year, month, and date, you must cycle through the following sequence of displays for both items and save the data entered. The data entered will not be saved if you exit the Program Mode or press the **Function** key before completing each step.

1. Remove the top cover and enter the previously set password as explained in the prior section. Upon correct password entry, the **Year** menu item will flash in the display.

2. Press the **Change** key until the correct two digit year (00 thru 50) is flashing in the display. Holding down the **Change** key for more than three seconds will increment the number in the display by ten.



3. When the correct year appears, press the **Enter** key. The display will automatically move to the **Month and Date** menu item. The first pair of digits (month) will flash in the display.



4. Press the **Change** key until the correct month number (01 thru 12) appears in the display, then press the **Enter** key.

5. The next set of digits, the **Date of the Month**, will flash in the display.



6. Press the **Change** key until the correct date of the month (01 thru 31) appears in the display, then press the **Enter** key.

7. The year, month, and date entered will flash in the display (seen here: July 27, 2007). To edit these settings, press the **Change** key. This will return you to the display described in step 1. To save these settings, press the **Enter** key.



8. When the year, month and date are saved, the next menu item, **Hours and Minutes** will appear in the display.



Note: After saving the date, the LED indicator on the front panel will automatically indicate the correct day of the week when returning to Normal Mode.

Hours and Minutes (Menu 1, Item 3)

Note: To set the hours and minutes, you must cycle through the following sequence of displays and save the data entered. The data entered will not be saved if you exit the Program Mode or press the **Function** key before completing all steps.

Note: All time programming is done in 24 hour time format, even if the time is displayed in 12 hour time format. If you wish to change the time format for the display, you must do so in the **Hours Display** menu item.

1. Remove the cover and enter the pre-determined password. For password entry information, refer to section *Password Entry Prior to Programming* on page 4-6. Upon correct password entry, the clock will enter the PROGRAM MODE. The **Year** menu item will automatically appear in the display.



2. If applicable, press the **Enter** key until the **Hours and Minutes** menu item appears in the display with the first pair of digits (hour) flashing.



3. Press the **Change** key until the correct hour (in 24 hour format, 00 thru 23) is flashing in the display. Holding down the **Change** key for more than three seconds will increment the number in the display by ten.



4. When the correct hour appears, press the **Enter** key. The second pair of digits, minutes, will begin to flash.



5. Press the **Change** key until the correct minutes (00 thru 59) appear in the display. Holding down the **Change** key for more than three seconds will increment the number in the display by ten.



6. When the correct minutes appears in the display, press the **Enter** key.



7. The hour and minutes entered will flash in the display. To edit these settings, press the **Change** key. This will return you to the display described in step 2. To save these settings, press the **Enter** key. When saved, the next menu item, **Daylight Saving Change Time**, will appear in the display.



Daylight Savings Time (DST) (Menu 2)

The DST function can be programmed to operate in one of three modes: change automatically each year by “rolling calendar;” change automatically by a fixed date; or set inactive. By default, the CP-5000 is configured for DST to be active, using the rolling calendar mode and employing the expanded 2007 standard.

To program for DST, you must specify the date that the DST period will begin and end. The time change will occur at 2:00 am on the begin and end dates. At the DST Begin Date the time will increment by one hour, and at the DST End Date the time will decrement by one hour.

Note: To set the DST Begin Date and End Date you must cycle through the parameters for each item and save the data entered. The data entered will not be saved if you exit the Program Mode or press the **Function** key before completing the steps as described.

Note: When setting the Begin Date and End Date for DST, you must set those dates based upon the current year. This rule must be applied regardless of whether the current date is within the DST date span or not.

Automatic Adjustment Settings





There are three items to be configured for Daylight Saving Time setup:

- Menu 2, Item 1
 - set to 0:* DST is disabled
 - set to 1:* DST employs a rolling calendar. Set the DST start date and end date once, and each year the correct DST change dates will auto-calculate based upon the initial year’s settings. Recommended.
 - Set to 2:* DST employs a fixed calendar. Set the DST start date and end date to this year’s dates, and each year that same date will be employed for the DST change dates. Not generally recommended.

- Menu 2, Item 2
Sets the DST start date's month and date.
- Menu 2, Item 3
Sets the DST end date's month and date.

Note: Setting the year is not necessary. If employing the rolling calendar (Menu 2, Item 1, option 1), the year is understood to be the current year and will be adjusted automatically into the future. If employing a fixed calendar (Menu 2, Item 1, option 2), the month and date are the same every year.

Programming DST (Menu 2, Items 1 – 3)

1. Remove the cover and enter the password. For password entry information, refer to section *Programming Password* on page 4-6. Upon correct password entry, the clock will enter the PROGRAM MODE. The **Year** menu item will automatically appear in the display.
 
2. Select the **Function** key until mode 21 (DST) appears.
 
3. Select the **Change** if a selection other than "1" (default) is desired. This is the rolling calendar option, and is the most common selection. Refer to Menu 2, Item 1 on page 4-9 for details regarding this option and others.
 
4. Select the **Enter** key twice. Mode 22 should appear and the month and date will appear. On this screen the start date for DST gets programmed. The month flashes.
 
5. Select the **Change** key until the correct month (1-12) appears for the *start* of DST. (For this example, programming for the year 2007 is shown. You must set the start date and end date for the current year, regardless of how far into the year's calendar when setting up DST. The rolling calendar function will adjust future years DST automatically based upon this initial setting.)
 

6. Select the **Enter** key, and now the date value flashes. Select the **Change** key until the correct date appears for the start of DST for the selected year.



7. Select **Enter** and the entire screen flashes. Select **Enter** again and Menu item 23 appears. In this menu the end date for DST can be programmed.



8. Select the **Change** key until the correct month (1-12) appears for the *end* of DST. (For this example, programming for the year 2007 is used.)



9. Select the **Enter** key, and now the date value flashes. Select the **Change** key until the correct date appears for the end of DST for the selected year.



10. Select **Enter** and the entire screen flashes. Select **Enter** again and the Save process is complete. The top cover may be returned to its normal position.

Disabling DST

1. Remove the cover and enter the password. For password entry information, refer to section *Password Entry Prior to Programming* on page 4-6. Upon correct password entry, the clock will enter the Program Mode. The **Year** menu item will automatically appear in the display.



2. Select the **Function** key until mode 21 (DST) appears.

3. Select the **Change** key once so that "0" is selected. This is the DST Disabled option.



4. Select the **Enter** key twice, then return the top cover. The DST function is now disabled.

Hours Display and Imprint (Menu 4, Items 1 – 7)

This group of menu items is used to set the time format (12 or 24 hour) of the display in Normal Mode and the imprint that will appear on the time card. To set the hours displayed and/or imprint proceed with the following steps:

1. Enter the Program Mode and press the **Function** key until the Item 1 - Hours Display appears in the display.

2. Press the **Change** key to select a value of "1" for 24-hour time format or "2" for 12-hour time format.



3. When the desired value appears, press the **Enter** key. The display will automatically move to Item 2 - Hour Imprint.

4. Press the **Change** key to select a value of "1" for 24-hour time format or "2" for 12-hour time format. If "2" is selected, an "AM" or "PM" will appear after the time in the imprint.

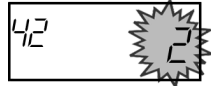

5. When the desired value appears, press the **Enter** key. The display will automatically move to Item 3 - Fraction of Hours (Minutes) Imprint.

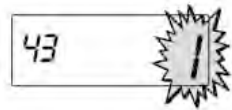

6. Using the **Change** key, select one of the following:

Accepted Values	Imprint
1	60 th hour
2	10 th hour
3	100 th A' (36 sec. = 0.01h)
4	100 th B (3 min. = 0.05h)

7. When the desired value appears, press the **Enter** key. The display will automatically move to Item 4 - Day Imprint.

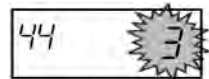

8. Using the **Change** key, select one of the following:

Accepted Values	Imprint
0	Off
1	Day of Week (1 to 7)
2	Day of Week (D1 to D7)
3	Day of Week (English)
4	Day of Week (Spanish)
5	Day of Week (French)
6	Day of Week (German)
7	Day of Week (Dutch)
8	Day of Week (Italian)

9. When the desired value appears, press the **Enter** key. The display will automatically move to the Item 5 - Year Imprint.



10. Press the **Change** key to select a value of "0" for no year imprint (OFF) or "1" to include the year in the imprint (ON).

11. When the desired value appears, press the **Enter** key. The display will automatically move to the Item 6 - Month Imprint.



12. Using the **Change** key, select one of the following:

Accepted Values	Imprint
0	None
1	Month (1 through 12)
2	Month (I through XII)
3	Month (English) (default)
4	Month (Spanish)
5	Month (French)
6	Month (German)
7	Month (Dutch)
8	Month (Italian)

13. When the desired value appears, press the **Enter** key. The display will automatically move to the Item 7 - Date Imprint.

14. Press the **Change** key to select a value of "0" to disable this feature or "1" to include an additional day of the month (00 to 31) in the imprint.

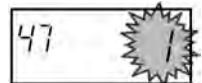

15. When the desired value appears, press the **Enter** key. When saved, the next menu item, Index No. Imprint, will appear in the display.



Index Number Imprint (Menu 4, Item 8)

This menu item is used to identify individual time clocks by printing a time clock-assigned code number onto the time card. The Index Number may be any number between 01 through 99.

Note: To disable the Index Number Imprint, enter "00".

1. Enter the Program Mode and press the **Function** key until the Index No. Imprint menu item appears in the display.



2. Press the **Change** key to select a value of 00 thru 99 that will be used to identify this time clock on a time card.
3. When the desired value appears, press the **Enter** key. The display will automatically move to the **Signal Duration** menu item.

Signal Duration (Menu 5, Item 1)

This selection is used to set the duration (in seconds) that the relay contacts of the installed signal device will be closed. It also defines the time the internal buzzer will sound.

1. Enter the Program Mode and press the **Function** key until the Signal Duration menu item appears in the display.



2. Press the **Change** key to select a duration of one to fifteen seconds that relay contacts of the signal device will be closed.

Note: While setting a one second duration is possible, it is not recommended.

3. When the desired value appears, press the **Enter** key. The display will automatically move to the Weekly Programming menu item.
4. Exit the Program Mode by re-installing the top cover, which automatically switches the unit to Normal Mode.

Weekly Programming (Items 01 – 80)

This menu allows you to create a weekly schedule that will enable or disable certain features of the CP-5000 at predetermined times of the day and on specific days of the week. This schedule is comprised of two components: Moments and Objects. They are:

Moments	Objects
Days of the Week	Built-in Buzzer
Time of the Day	Signal
	Color of Imprint

Note: Days are indicated numerically, and begin on Monday (1) and end on Sunday (7).

Functions Available in Weekly Programming

- **Buzzer:** *Menu code number 1.* This function activates a small internal buzzer, providing a locally-heard audible signal of medium tone. The duration of time for the buzzer's signal is controlled by the Signal function, next.
- **Signal:** *Menu code number 2.* This function activates the internal relay controlling an external signal device.

Note: The duration (1 to 15 seconds) that the relay and buzzer will be ON for is set in the Signal Duration (page 4-14) menu item.

- **Ink Color Selection:** *Menu code number 3.*

Up to eighty Weekly Programs or schedules can be entered into the CP-5000. Programming charts are provided in the Appendix to help you set up weekly programs. A sample **Weekly Program** is shown in the following table:

Pgrm No.	Moment							Code Number / Object			
	Days							Time	1. Buzzer	2. Signal	3. Color
	1	2	3	4	5	6	7	HH:MM	0: Off 1: On	0: Off 1: On	0: No Change 1: Black 2: Red
01		X		X	X			08:27	0	1	1
02		X		X	X			10:12	1	0	2

In this example, at 8:27 am, on the second (Tuesday), fourth (Thursday), and fifth (Friday) day of the week, the external signal will activate and the CP-5000 will print in black ink. At 10:12 am on the same days, the built-in buzzer will sound and the CP-5000 will print in red ink.

Creating a Weekly Program

Note: To create a program or schedule, you must cycle through the sequence of displays of each program number and save the data entered. The data entered will not be saved if you exit the Program Mode or press the **Function** key before completing each sequence.

1. Enter the Program Mode and press the **Function** key until the Weekly Program menu item appears in the display. The first program number will appear, with the first cursor or day of the week (Monday) flashing in the display.



2. Press the **Change** key to (deselect) omit days of the week from the schedule or press the **Enter** key to (select) include days of the week on the schedule. Days that the schedule will operate on will be shown in the display as cursors.



3. When the days of the week are selected, the display will flash the hour of the selected days that the schedule will be activated.



Note: All time programming is done in 24 hour time format.

4. Press the **Change** key until the hour of the day (00 thru 23) appears in the display, then press the **Enter** key. The digits that represent the minutes of the hour will appear and flash in the display.



5. Press the **Change** key until the correct minutes (00 thru 59) appear in the display, then press the **Enter** key. This is the time (hours and minutes) that the schedule will be activated on the selected days of the week. The display will move to the Buzzer, which is the first object to be turned on or off in the schedule.



6. Press the **Change** key to enter a value of "0" to disable (OFF) or "1" to enable (ON) the **Buzzer**. When the correct value appears in the display, press the **Enter** key. The display will move to the next object, Signal.



Note: The duration (1 to 15 seconds) that the Buzzer will be ON for is set in the Signal Duration menu (page 4-14).

7. Press the **Change** key to enter a value of “0” to disable (OFF) or “1” to enable (ON) **Signal**. When the correct value appears in the display, press the **Enter** key. The display will move to the next object, Color.

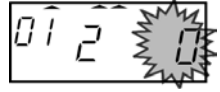

Note: The duration (1 to 15 seconds) that the relay contacts of **Signal** will be closed is set in the Signal Duration menu (page 4-14).

8. Press the **Change** key to enter a value of “1” to change to black ink, or “2” to change to red ink.



Note: If you program a color change, you must program another step or schedule to return the ribbon to its original color.

9. When the desired value is displayed, press **Enter** key. The program number, days of the week, and time of the day that the program will be activated will flash in the display. To edit these settings, press the **Change** key. This will return you to the display described in step 1. To save these settings, press the **Enter** key. When saved, the display will move to the next program number.



10. Repeat the previous steps to enter in the next program. If a mistake is made at any time, the fastest way to return to the Weekly program to be changed is to select the **Function** key and cycle through the other programming options until the Weekly programming reappears.



Warning! Do not schedule to programs to occur at the same time; the results will be inconsistent and unpredictable.

Obtaining a Printout of Programmed Data (Menu 7)

1. If you have not already done so, enter the Program Mode and press the **Function** key until the **Program Printout** menu item (7) appears in the display. The default value of this item is zero or OFF.



2. Press the **Change** key to change the value in the display to "1" or ON.



3. With "1" flashing in the display, press the **Enter** key. The "1" will cease to flash.



4. Insert a time card. All Basic Programming information will be printed on the time card. The information will be printed in red ink.

```

AMANO CINCINNATI INC
08/04/07 16:35
CP5000 PROGRAM INFO
VERSION 00.00
11=07 12=08/03
13=14:53
21=00 22=03/11 23=11/04
31=00 00
41=02 42=02 43=01 44=03
45=01 46=03 47=01 48=00
51=05
|||||
    
```

5. If you have programmed one or more Weekly Programs, insert another time card (or the reverse side of the one used in step 4) to obtain a printout. Up to twenty Weekly Programs are printed per card.

```

AMANO CINCINNATI INC
08/07/07 09:46
CP5000 PROGRAM INFO
STP DAYS TIME BZR RLY CLR
01 12----- 10:00 BZ R1 RED
02 ----- 00:00
03 ----- 00:00
    
```

In the sample above, program one (STP column: 01) is configured. For that event, which takes place Mondays and Tuesdays (DAYS column: 1 and 2) at 10:00 a.m., the buzzer (BZR) will sound, the relay (RLY) will close, and the ink (CLR) will change to red color.

There are no programmed events for programs two and three (STP 2 or STP 3).

6. To stop printing at any time, press and hold either the **Change** or **Enter** key. Only the currently inserted time card will be printed on, and the remainder of the programming data will not be printed.
7. When printing is completed, the display will automatically move to the next menu. Exit the Program Mode to Normal Mode by re-installing the top cover.

Editing Weekly Programs

1. Obtain a printout of the current Weekly Programs.
2. Mark on the printout the desired Weekly Program that you want to change.
3. Enter the Program Mode and press the **Function** key until the Weekly Program menu item appears in the display.
4. Press and hold the **Enter** key until the desired program number appears. To move to previously numbered Weekly Programs, press and hold the **Change** key.
5. Change the Weekly Program as desired. For the changes to be in saved, you must cycle through the sequence of parameters for the program and press **Enter** to save your changes.
6. After saving the program, press the **Function** key to move to the Program Printout menu item and print out a copy of the program to verify your changes.

Adding Additional Weekly Programs

1. Obtain a printout of the current Weekly Programs.
2. Mark the last Weekly Program on the printout.
3. Enter the Program Mode and press the **Function** key until the Weekly Program menu item appears in the display.
4. Press and hold the **Enter** key until an empty Weekly Program appears in the display. The program number should be the last program number on the printout + 1.
5. Enter the program parameters as desired. For the changes to be in saved, you must cycle through the sequence of parameters for the program and press **Enter** to save your changes.
6. After saving the program, press the **Function** key to move to the Program Printout menu item and print out a copy of the program to verify your settings.

Deleting a Weekly Program

Note: Weekly Program number 1 can not be deleted.

1. Obtain a printout of the current Weekly Programs.
2. Mark on the printout the desired Weekly Program that you want to delete.
3. Enter the Program Mode and press the **Function** key until the Weekly Program menu item appears in the display.
4. Press and hold the **Enter** key until the desired weekly program number appears. To move to previously numbered Weekly Programs, press and hold the **Change** key.
5. Press the **Change** key to delete all days of the week that the program was scheduled for.
6. All the objects in the program will flash in the display.
7. Press the **Enter** key to delete this program. The remainder of the programs in the CP-5000 will automatically have their program number moved down one to fill the empty space left by the program that was just deleted. For example, if program number seven was deleted, program number eight will now be program number seven.
8. After saving the program, press the **Function** key to move to the Program Printout menu item and print out a copy of the program to check.

Service

With the exception of the ribbon and the time/date memory backup battery, there are no user-serviceable parts in the time recorder. Do not attempt to service/disassemble the time recorder other than prescribed in this manual.

Exterior

Gently wipe the exterior of the unit with a soft cloth dampened with water and a neutral detergent. Do not use thinner, benzene, or similar solvent.

Ribbon Replacement

The ribbon should be replaced when the imprint of the time card appears light, overprinting (one line of print overlapping another) occurs or when the following message appears in the display:



Err 1

Always use Amano-approved ribbons. Non-Amano ribbons bind in the printer carriage, produce weak quality prints and leave ink residue on print head, rollers, and time cards.

Perform the following steps to replace the ribbon:

1. Remove the top cover and set the **Mode Switch** to Program/Ink.
2. Grasp the front panel from the bottom and flip it up.
3. Using two fingers, press the two white release tabs down and towards the case, and while holding them, remove the ribbon.

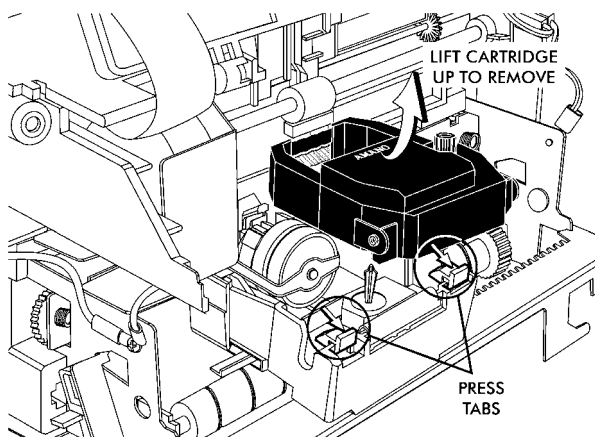

4. Insert a new ribbon between the ribbon guide and the printer head.
5. Press the ribbon down until it clicks into place. Turn the knob clockwise to remove any slack in the ribbon.

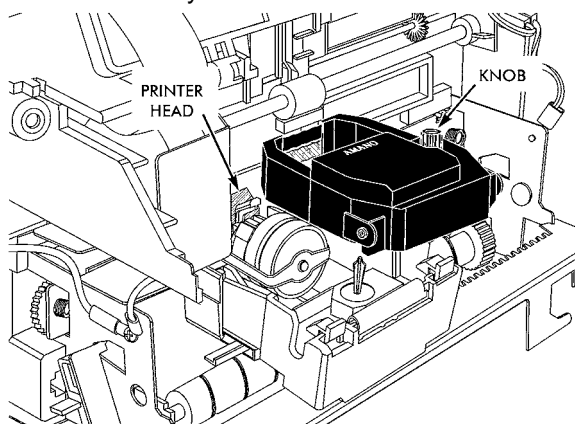

6. Rotate the front panel down until it clicks in place.
7. Set the **Mode** Switch back to Normal and replace the top cover.
8. Insert a time card into the card throat to check the printing quality and to confirm that you have installed the ribbon properly.

Time/Date Memory Backup Battery

Amano recommends the replacement of this battery every five years. The battery maintains the time and date settings in the CP-5000 during power interruptions.

Perform the following steps to replace the battery:

1. Disconnect the power cord from the AC outlet.

⚠ Warning! Do not proceed without disconnecting AC power. A serious shock hazard exists when the front cover is off and AC power is applied.

2. Remove the top cover.
3. Remove the front cover (see Chapter 2).
4. Using an insulated tool (plastic screwdriver, toothpick, etc.) push up lightly on either bottom corner of the battery to lift it partially out of the battery holder. Grasp the top of the battery and lift it out of the holder.

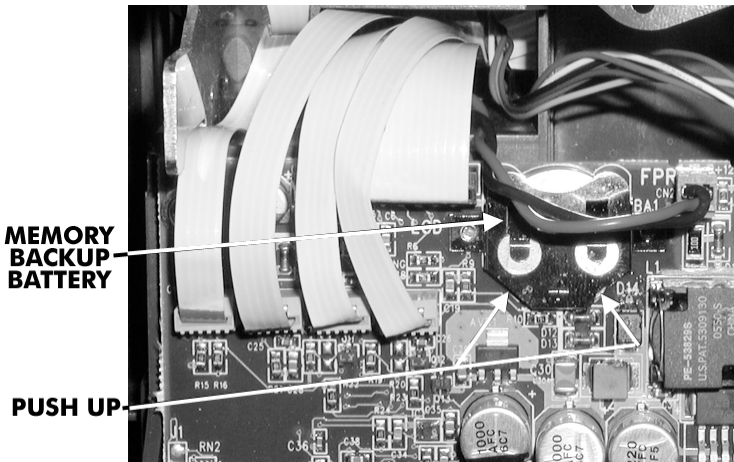

5. Install the new battery with the positive (+) side facing you. Press down until the battery is fully seated in the battery holder.
6. Replace the front cover.

7. Plug the power cord into the AC outlet.
8. Reprogram the date and time.

Note: If the Full Power Reserve Battery option is installed, it might not be necessary to reprogram the date and time; verify the settings before proceeding.

9. Replace the top cover.

Introduction

If your CP-5000 should fail to operate properly, you should perform the following to determine the cause:

- Visually inspect the unit.
- Obtain a printout of programmed data and verify the programming.
- Check that AC power is connected.
- Check the condition of the time card, if it is dirty or damaged, it must be replaced.
- Run the specified test in the Diagnostics menu.
- Press the Reset key.
- Reinitialize the unit to reset the unit to defaults.

If, after performing the above, you still are unable to resolve the problem or feel that your unit requires servicing, contact your local Amano dealer.

General Problems

Signal

If you are experiencing a problem with the relay signal circuit, you should perform the following:

- Verify that the connections to **TB1** (page 2-6) are correct.
- Verify that the external device is working properly.
- Verify that the maximum load is not exceeded.
- Check to see that the appropriate surge absorber is properly connected to the external device.
- Check all wiring.
- Obtain a printout of programmed data in your CP-5000. Verify that **Signal** is correctly programmed in the **Weekly Program**.

- Run the Signal Test from the **Diagnostics** menu to check if the **Signal** relay is operating properly. If it is not, contact your local Amano dealer.

Foreign Object or Material

Only a time card should be inserted into the unit. If foreign objects or materials get inside the CP-5000, you must disconnect the AC power and the battery, and remove the foreign objects.

Programming

If you suspect a programming problem, it is recommended that you obtain a printout of the programmed information as described in **Chapter 4** and troubleshoot the programmed data, or initialize the clock (page 2-10) to reset the unit to defaults.

If you are unable to resolve the problem, please contact your local Amano dealer.

Key Failure

If you suspect that one of the keys has failed, you should run the Key Test in the Diagnostics menu.

Audible Beeps

The time recorder is equipped with an audible alarm that “beeps”. The beeps will vary in duration and corresponding meaning (see the following).

Action	Cause
One Beep	Time Card improperly inserted
Two Beeps	<ul style="list-style-type: none"> • No more print space on Time Card, column full • Time Card was removed too soon or is too short
Continous Beep	LCD Display not connected or not functioning

Error Messages

There are nine possible error messages (**Err 1** thru **Err 9**) that can appear in the display. When one of the errors occur, the CP-5000 will display the error message and may beep. The display will return to normal after an error message is displayed.

Err 1 thru Err 9

Printing or Ribbon Error



The time card sensors could not detect the **Column Position Block**. Possible reasons are:

- The imprint quality (black color) is poor or too light. Replace the ribbon cassette.
- No ribbon cassette is inside the machine. Install a ribbon cassette.
- The ribbon cassette is not seated correctly in the printer carriage. Reinstall the ribbon cassette.
- The red color is active in front of the dot head. This is due to normal interference between the slider and printer carriage. Push slider to normal (protruding from the left side of the printer carriage) position.

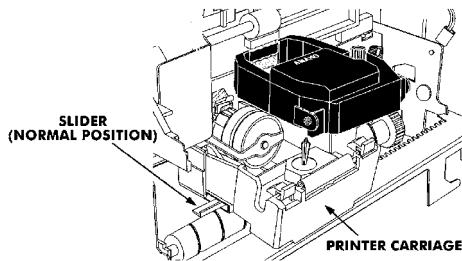

- Printer or printer carriage is damaged. Contact your local Amano dealer.
- A non-Amano ribbon was used. Always use Amano approved ribbons: non-Amano ribbons bind in the printer carriage, produce weak quality prints and ink residue on print head, rollers, and time card.

- The slider on the printer carriage is not moving correctly due to a missing black plastic bushing in the small holes on the right or left side of the printer frame. Contact your local Amano dealer.
- There is dirt, oil, dust, or ink residue on the surface of the time card or the time card surface is too rough for the time card sensor to detect the **Column Position Block**. Replace the card.
- The background color of the time card is too dark.

Time Card Error

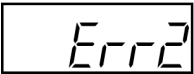

When this message is displayed, printing will stop immediately. This occurs when the time card is pushed or pulled when fed into the card throat or during the printing cycle.

Time Card is Full

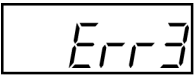

This message indicates that the time card is full; no more space is available for printing.

Invalid Card Edge Detection

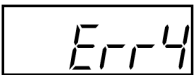

The block sensor is not detecting the edge of the card. Possible causes are:

- The rubber roller in the card transport mechanism is dirty. The roller can be cleaned with Fantastik[®] spray cleaner on a clean cloth or cotton swab. Be sure to completely dry all residue.

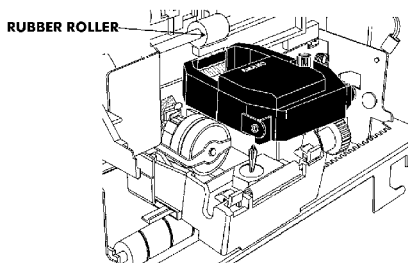

- The block sensor is malfunctioning. If this condition persists, contact your local Amano dealer.

Card not in Clock

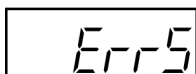

This message will be displayed if the card is not pulled into the transport mechanism after five attempts. This can occur if someone fails to release the card when attempting a punch.

Block Read Sensor Error

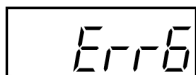

The block sensor is not detecting the **Column Position Block** after printing due to the card not moving (due to slippage or interference) or a block sensor malfunction. If this condition persists, contact your local Amano dealer.

Timing Sensor Error

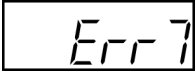

This error occurs when a card gets stuck or irregular card motion is detected by the card transport mechanism. Possible causes are:

- A non-standard time card shape is used or the time card is forced into the card throat. In either case, the time card sensors detect the presence of the time card, but the unit is unable to flush out the card. The time card has to be removed manually to resolve this problem.
- The rubber roller in the card transport mechanism is dirty. The roller should be cleaned; see page 6-4 for details.
- The time card feed mechanism or time card sensors are damaged.

Password Error

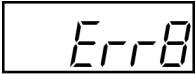

This message is displayed when an invalid password is entered when attempting to access programming mode.

Real Time Clock Error

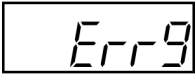

This error indicates an unexpected clock value.

Blank Display



When this condition occurs, the CP-5000 will also emit a continuous beep. If possible, perform the **LCD Test** in the **Diagnostics** menu. If this condition persists, contact your local Amano dealer.

Display Related Problems

Low Battery

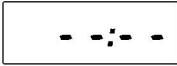

If the accessory battery is installed and operating the clock during a power failure, this display indicates that the battery is weak. During this low battery display indication, the time and date will be maintained. The number of prints made should be kept to a minimum to conserve power. There will be no loss of programmed data. The clock will return to normal operation when AC power is restored.

If there is no damage to the battery, the battery will be recharged by the AC power supply when power is restored. Please allow the CP-5000 24 hours to recharge the battery completely.

Power Failure

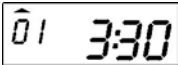

A blinking LED and constant colon in the display indicates an AC power failure. When this occurs, the operation of the CP-5000 is taken over by the internal battery.

If AC power is connected and working, and the display indicates a power failure, contact your local Amano dealer.

Inaccurate Clock

The clock frequency is factory set. If you feel that your clock is inaccurate, please contact your local Amano dealer.

LED's Not Functioning

If the LED's fail to function on the front panel, run the **LED** test in the **Diagnostics** menu. If the problem is not resolved, contact your local Amano dealer.

Hour Change

If the time displayed is off by an hour (either up or down), one of the following may have occurred:

- The programmed DST settings are incorrect.
- The **Enter** or **Change** key was inadvertently pressed.

Card Feed Problems

Card Refused

- Check whether the column of your time card is already completely filled with imprints. If all positions are already occupied by an imprint, two beeps will sound, and the card will be rejected without making an imprint.
- Check the condition of the time card. If there is dirt, oil, dust, or ink residue on the card, the time card sensors cannot read the **Column Position Block**.
- Verify the imprint position. If the **Column Position Block** is positioned on artwork or a column line, the time card sensor will read this as a column full condition.
- A non-Amano ribbon was used. Always use Amano approved ribbons, non-Amano ribbons bind in the printer carriage, and produce weak quality prints, and ink residue on print head, rollers, and time card.
- The background color of your time card is too dark

Card Cannot Enter or Card Blocked

When you insert a time card into the card throat, the feed motor will grasp it and pull it down to be printed. The feed motor will attempt to grasp the card a maximum of three times. If the third attempt fails, a long beep will sound, the feed motor will shut off, and the card must be manually removed from the card throat.

If a card is blocked or stuck inside the card throat after the imprint has been printed, the feed motor will attempt to flush out the card a maximum of three times. If the card is still inside the card throat after the third attempt, the feed motor will shut down, leaving the card inside the unit. If the card was unable to be flushed out by the feed motor, it must be manually removed.

Card Refused, Date and Time in Display

If a time card is inserted into the card throat, refused, and a beep sounds, the time card is too short. The time card sensors compare the top margin of the time card with the imprint position. If it can not reach this imprint position, the unit will beep and refuse the card.

Imprint Problems

Overprint

The **Column Position Block** in the imprint is used by the CP-5000 to prevent overprinting. If your CP-5000 is overprinting, any one of the following may be the cause:

- The time card was pushed, pulled, or moved during the printing cycle causing the time card sensors to misinterpret the **Column Position Block**.
- The quality of the ribbon is poor. The system can not detect a weak **Column Position Block**.
- A non-Amano ribbon was used. Always use Amano approved ribbons: non-Amano ribbons bind in the printer carriage, produce weak quality prints and ink residue on print head, rollers, and time card.
- The background color of the time card is too dark.
- The surface of the time card is too rough or there is dirt, oil, dust, or ink residue on the card.

Imprint Position Wrong

If your CP-5000 is functioning normally, but the position of the imprint is incorrect, perform the following:

- Verify that the programmed date and time are correct.
- A non-Amano ribbon was used. Always use Amano approved ribbons: non-Amano ribbons bind in the printer carriage, produce weak quality prints and ink residue on print head, rollers, and time card.
- The feed rollers may be damaged or require cleaning. Contact your local Amano dealer.

Wrong Color Printed

The CP-5000 has the ability to print in red or black ink. When the top cover is installed (Normal Mode), the default ink color is black, and the color of ink printed is determined by the settings in the **Weekly Program**. When the top cover is removed (Program Mode), the CP-5000 will print in red. If the wrong color is being printed by your CP-5000, please perform the following:

- Obtain a print out of the programmed data from the CP-5000. Verify that your **Weekly Program** settings are correct.
- The red color is active in front of the dot head. This is due to normal interference between slider and printer carriage. Push slider to normal position.
- Printer or printer carriage is damaged. Contact your local Amano dealer.
- The slider on the printer carriage is not moving correctly due to a missing black plastic bushing in the small hole of the right printer frame. Contact your local Amano dealer.
- The ribbon cassette is not seated correctly in the printer carriage. Reinstall the ribbon cassette.
- Printer or printer carriage is damaged. Contact your local Amano dealer.

Weak or Light Printing

Please refer to **Printing or Ribbon Error Message, Err1** section of this chapter for troubleshooting weak or light printing problems.

Diagnostics (Menu 8)

The Diagnostics Menu is used to run specific diagnostic routines for troubleshooting and determining the condition of your CP-5000.

The **Diagnostics** menu is accessed by entering the Program Mode, and pressing the **Function** key until the LED Test (Menu 8, Item 1) appears in the display and the last LED indicator is illuminated.



The general guidelines for the Diagnostics Menu are as follows:



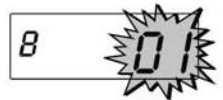

- Each test is indicated by a specific number (refer to the Programming Guide, page 4-3) flashing in the display.
- To select and start a test, press the **Enter** key.
- To stop a test press the **Enter** key again. A beep will sound and the test number will flash in the display.
- Press the **Change** key to move to the next test.
- Press the **Function** key to leave the Diagnostics Menu.

LED Test (Menu 8, Item 1)

1. If you have not already done so, enter the Program Mode and press the **Function** key until the LED Test menu item appears in the display.
2. Press the **Enter** key to select and start the test. The test number will cease to flash in the display, and the LED indicators will illuminate one at a time from left to right.
3. Press the **Enter** key to stop the test. A beep will sound and the test number will flash in the display.
4. Press the **Change** key to move to the next test or exit the Diagnostic Menu by pressing the **Function** key, or by exiting the Program Mode.



Mode and Keys Test (Menu 8, Item 2)

1. If you have not already done so, enter the Program Mode and press the **Function** key until the LED Test menu item appears in the display.
2. Press the **Change** key. The Mode and Keys Test menu item will appear in the display.
3. Press the **Enter** key to select and start the test. The test number will cease to flash in the display, and the first LED indicator (on the left side of the front panel) will illuminate.
4. Place the **Mode Switch** in the Normal position. The LED indicator should turn off.
5. Set the **Mode Switch** back to Program/Ink. The LED indicator should illuminate. Repeat this sequence several times.
6. To test the keys, place the **Mode Switch** in the Normal position. The LED indicator should turn off.
7. Press the **Function** key, the second LED indicator will illuminate.
8. Press the **Enter** key, the third LED indicator will illuminate.
9. Press the **Change** key, the fourth LED indicator will illuminate. Repeat this sequence several times.
10. Set the **Mode Switch** back to Program/Ink and press the **Enter** key to stop the test. A beep will sound and the test number will flash in the display.
11. Press the **Change** key to move to the next test or exit the Diagnostics Menu by pressing the **Function** key, or by exiting the Program Mode.

LCD Test (Menu 8, Item 3)

1. If you have not already done so, enter the Program Mode and press the **Function** key until the LED Test menu item appears in the display.
2. Press the **Change** key twice. The LCD Test menu item will appear in the display.
3. Press the **Enter** key to select and start the test. The test number will disappear and all the segments of the LCD display will flash.
4. Press the **Enter** key to stop the test. A beep will sound and the test number will flash in the display.
5. Press the **Change** key to move to the next test or exit the Diagnostics Menu by pressing the **Function** key, or by exiting the Program Mode.



EPROM (Memory) Test (Menu 8, Item 4)

1. If you have not already done so, enter the Program Mode and press the **Function** key until the LED Test menu item appears in the display.
2. Press the **Change** key three times. The EPROM Test menu item will appear in the display.
3. Press the **Enter** key to select and start the test. The test number will cease to flash in the display, and the second LED will illuminate and the size of the EPROM will be in the display.

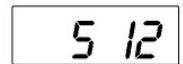

4. Press the **Enter** key to stop the test. A beep will sound and the test number will flash in the display.
5. Press the **Change** key to move to the next test or exit the Diagnostics Menu by pressing the **Function** key, or by exiting the Program Mode.



Buzzer Test (Menu 8, Item 5)

1. If you have not already done so, enter the Program Mode and press the **Function** key until the LED Test menu item appears in the display.
2. Press the **Change** key four times. The Buzzer Test menu item will appear in the display.
3. Press the **Enter** key to select and start the test. The test number will cease to flash in the display, and the Buzzer will sound for a maximum of eight beeps.
4. Press the **Enter** key to stop the test. A beep will sound and the test number will flash in the display.
5. Press the **Change** key to move to the next test or exit the Diagnostics Menu by pressing the **Function** key, or by exiting the Program Mode.

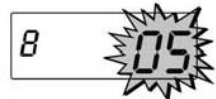

Signal Test (Menu 8, Item 6)

1. If you have not already done so, enter the Program Mode and press the **Function** key until the LED Test menu item appears in the display.
2. Press the **Change** key five times. The Signal Test menu item will appear in the display.
3. Press the **Enter** key to select and start the test. The test number will cease to flash in the display and you will hear a clicking sound as the relay contacts open and close.
4. Press the **Enter** key to stop the test. A beep will sound and the test number will flash in the display.
5. Press the **Change** key twice to move to the next test or exit the Diagnostics Menu by pressing the **Function** key, or by exiting the Program Mode.



Motor Test (Menu 8, Item 7)

1. If you have not already done so, enter the Program Mode and press the **Function** key until the LED Test menu item appears in the display.
2. Press the **Change** key six times. The Motor Test Number menu item will appear in the display.
3. Press the **Enter** key to select and start the test. The test number will cease to flash in the display and you will hear the sounds of the motor whirring. The cycle completes in a few seconds.
4. Press the **Enter** key to complete the test. A beep will sound and the test number will flash in the display.
5. Press the **Change** key to move to the next test or exit the Diagnostics menu by pressing the **Function** key, or by exiting the Program Mode.



Firmware Version Number (Menu 8, Item 8)

1. If you have not already done so, enter the Program Mode and press the **Function** key until the LED Test menu item appears in the display.
2. Press the **Change** key seven times. The Firmware Version Number menu item will appear in the display.
3. Press the **Enter** key to start the version display function. The test number will cease to flash in the and the firmware version will display.
4. Press the **Enter** key to stop the test. A beep will sound and the test number will flash in the display.
5. Press the **Change** key to move to the next test or exit the Diagnostics menu by pressing the **Function** key, or by exiting the Program Mode.

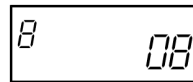

Print Counter (Menu 8, Item 9)

1. If you have not already done so, enter the Program Mode and press the **Function** key until the LED Test menu item appears in the display.
2. Press the **Change** key eight times. The Print Counter menu item will appear in the display.
3. Press the **Enter** key to select and the print counts. A beep will sound and the number of imprints the clock has made will be displayed.
4. Press the **Enter** key to complete the test. A beep will sound and the test number will flash in the display.
5. Press the **Function** key to exit the Diagnostics menu, or exit Program Mode.

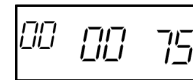

Card Print Test (Menu 8, Item 10)

This test, for factory use only, will sequentially print on a time card until it is full. It is not recommended for field use as it rapidly consumes the ink ribbon.

Calibration & Sensor Tests (Menu 8, Items 11 - 18)

These are calibration tests for factory use only.

Chapter 7: Appendix

The following blank chart is provided to assist you in creating **Weekly Programs** for your CP-5000.

Program No.	Moment							Object			
	Days							Time	1. Buzzer	2. Signal	3. Color
	1	2	3	4	5	6	7	HH:MM	0: Off 1: On	0: Off 1: On	0: No Change 1: Black 2: Red
01								:			
02								:			
03								:			
04								:			
05								:			
06								:			
07								:			
08								:			
09								:			
10								:			
11								:			
12								:			
13								:			
14								:			
15								:			
16								:			
17								:			
18								:			
19								:			
20								:			
21								:			
22								:			
23								:			
24								:			
25								:			
26								:			
27								:			
28								:			
29								:			
30								:			

(Chart continued on next page)

Program No.	Moment								Object		
	Days							Time	1. Buzzer	2. Signal	3. Color
	1	2	3	4	5	6	7	HH:MM	0: Off 1: On	0: Off 1: On	0: No Change 1: Black 2: Red
31								:			
32								:			
33								:			
34								:			
35								:			
36								:			
37								:			
38								:			
39								:			
40								:			
41								:			
42								:			
43								:			
44								:			
45								:			
46								:			
47								:			
48								:			
49								:			
50								:			
51								:			
52								:			
53								:			
54								:			
55								:			
56								:			
57								:			
58								:			
59								:			
60								:			

(Chart continued on next page)

Program No.	Moment							Object			
	Days							Time	1. Buzzer	2. Signal	3. Color
	1	2	3	4	5	6	7	HH:MM	0: Off 1: On	0: Off 1: On	0: No Change 1: Black 2: Red
61											
62											
63											
64											
65											
66											
67											
68											
69											
70											
71											
72											
73											
74											
75											
76											
77											
78											
79											
80											

This page intentionally left blank.

AMANO®

*Corporate Headquarters
140 Harrison Avenue, Roseland, NJ 07068-1239*

(800) 526-2559

www.amano.com